

Entry Max Series Pizza Ovens With Single and Double Chambers

ITEM: 40635 40636 45199
MODEL: PE-IT-0019-S PE-IT-0038-D PE-IT-0038-DS

40636/45199



40635



Practical, and reliable

The Entry Max line is characterized by an autonomous management of the two operating temperatures for the ceiling and bedplate, distributing the heat evenly over the stone. The Entry Max electric oven is a solid, well-designed, easy to use and incredibly functional instrument, thanks also to the glass door that allows monitoring every stage of the cooking process.

FEATURES:

- Stainless steel front, two mechanical thermostats per chamber, heat resistant, light, main switch for each chamber, stainless steel door with glass and handle (Each chamber is independent)
- Up to 2 single-chamber oven can be placed on top of each other without the need for an exhauster connection
- Insulation is evaporated fiberglass
- Left-sided handles
- Upon request the machines can be produced in a "full refractory stone" version and for single-phase operation.

* Special Order are available for the following upon request: stands, casters, hoods, vents and suction motor

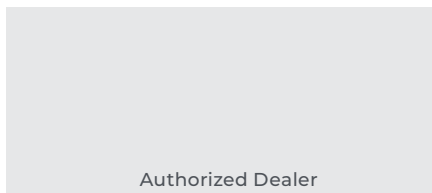

Technical Drawings

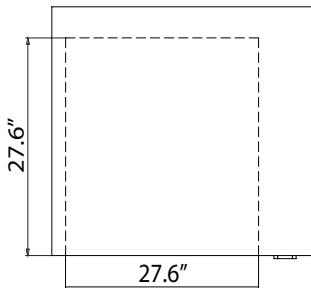
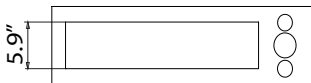
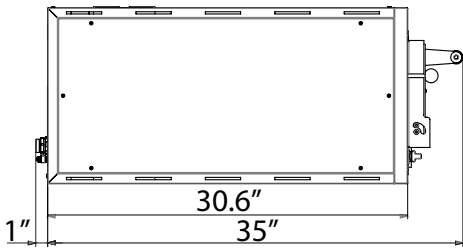
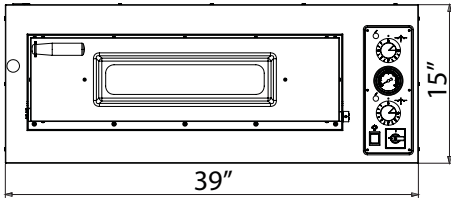





Technical Specification

Item	40635
Model	PE-IT-0019-S
Maximum Temperature	842° F (450° C)
Power	5600 W
Electrical	220V / 60Hz / 3Ph
Chamber Dimensions (WDH)	27.6" x 27.6" x 5.9" (700 x 700 x 150 mm)
Full Refractory Stone Dimensions (WDH)	26.4" x 27" x 5.31" (670 x 685 x 135 mm)
Net Weight	163 lb. (74 kg.)
Net Dimensions (WDH)	39" x 36" x 15" (990 x 920 x 380 mm)
Gross Weight	170 lb. (77 kg.)
Gross Dimensions (WDH)	40.2" x 39" x 20.9" (1020 x 990 x 530 mm)
Plug Type	Bare Wire

Related Accessories - (Sold Separately)

Item	Description
41600	Stainless Steel Stand
41607	Stainless Steel Hood
40645	Wheels for All Pizza Oven Stands

			
max 4 x 12"	max 4 x 13"	max 1 x 18"	max 1 x (24" x 16")



Technical Drawings

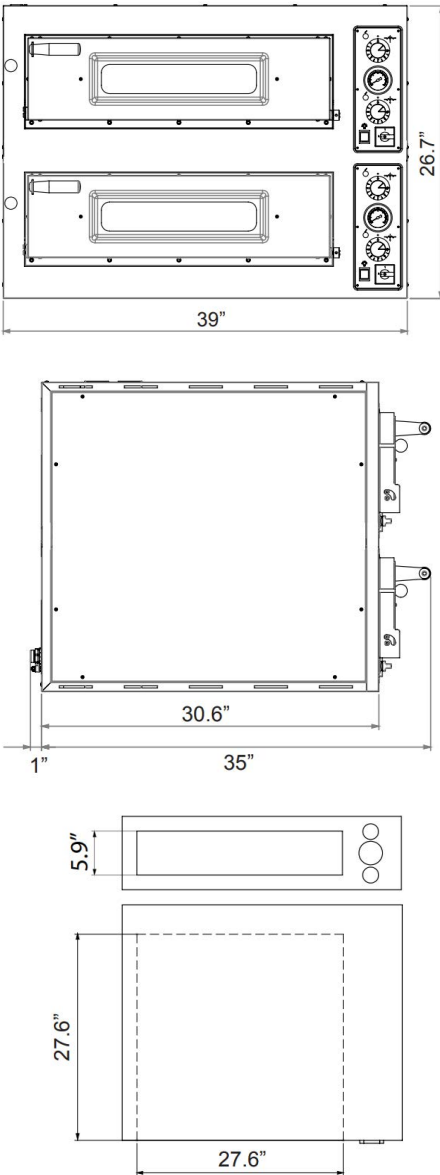

Technical Specification

Features	3 Phases	1 Phase
Item	40636	45199
Model	PE-IT-0038-D	PE-IT-0038-DS
Maximum Temperature	842° F (450° C)	
Power	11200 W	
Electrical	220V / 60Hz / 3Ph	220V / 60Hz / 1Ph
Chamber Dimensions (WDH)	27.6" x 27.6" x 5.9" (x2) (700 x 700 x 150 mm) (x2)	
Full Refractory Stone Dimensions (WDH)	26.4" x 27" X 5.31" (670 x 685 x 135 mm)	
Net Weight	328.5 lb. (149 kg.)	
Net Dimensions (WDH)	39" x 36" x 26.7" (990 x 920 x 680 mm)	
Gross Weight	363 lb. (165 kg.)	
Gross Dimensions (WDH)	40.2" x 39" x 32.3" (1020 x 990 x 820 mm)	
Plug Type	Bare Wire	

Related Accessories - (Sold Separately)

Item	Description
41422	Stainless Steel Stand
41607	Stainless Steel Hood
40645	Wheels for All Pizza Oven Stands

